

Click to Clear Form

Clear

caution: this clears all form fields

HEMCO Corporation ISO 9001: 2008

Plan-A-UniFlow LE AireStream Fume Hoods

Click to Submit Form

Submit

window opens, select your e-mail service, add a message, press send

HEMCO Corporation PH:816-796-2900 Fax:816-796-3333 info@HEMCOCORP.COM

PLAN-A-HOOD LE AIRESTREAM FUME HOOD

SHEET 1 OF 2

CUSTOMER _____
 BY _____ DATE _____
 PHONE _____
 FAX _____
 EMAIL _____

CUSTOMER APPROVAL APPROVED AS SHOWN
 APPROVED AS NOTED (PLEASE MARK CORRECTIONS IN RED)
 NOT APPROVED (PLEASE INDICATE REASON)
 CUSTOMER SIGNATURE _____ DATE _____

CATALOG NO #
 FUME HOOD WIDTH:
 FUME HOOD DEPTH:
 FUME HOOD HEIGHT:
 PROCESSES TO BE PERFORMED:

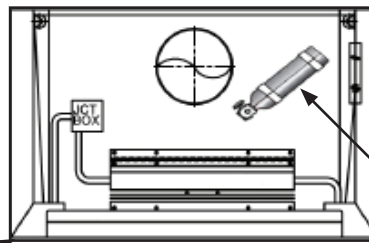

TOP VIEW

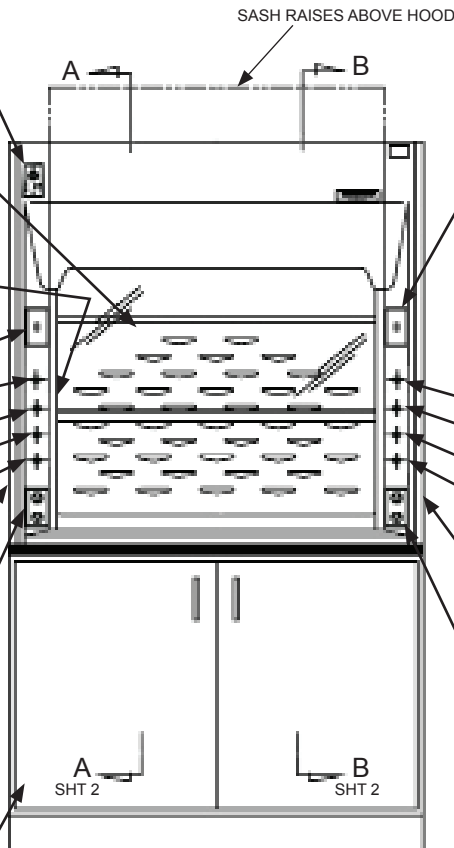

PLAN VIEW OF WORK SURFACE

OTHER FUME HOOD

AIR BYPASS	
AUXILIARY AIR	
RADIOISOTOPE	
PERCHLORIC ACID	
DUAL ENTRY	
ADA	

FIRE EXTINGUISHER CAT. NO

20 SQ. FT DRY CHEMICAL	
30 SQ. FT DRY CHEMICAL	
OTHER	

BLOWER SWITCH CAT. NO

TOGGLE SWITCH 125V,15A	
TOGGLE SWITCH 125V, 20A	
TOGGLE SWITCH. 250V, 20A	
TOGGLE SWITCH W/PILOT	
MOTOR STARTER SWITCH	

SERVICE FIXTURES CAT. NO

SERVICE REQUIRED	
SERVICE REQUIRED	
SERVICE REQUIRED	
OTHER	
SPECIFY AIR,GAS,VAC,C/W OR OTHER	

ACCESS PANEL

INSIDE LOCATION	
OUTSIDE LOCATION	

ELECT. SERVICE LT CAT. NO

DUPLEX RECEPT.125V,15A	
DUPLEX RECEPT.125V, 20A	
SIMPLEX RECEPT. 250V	
DUPLEX GFI 125V, 15A	
DUPLEX GFI 125V, 20A	

WORKSURFACE CAT. NO

EPOXY RESIN	
PHENOLIC RESIN	
316 STAINLESS STEEL	
304 STAINLESS STEEL	

AIRFLOW MONITOR CAT. NO

FLUSH MOUNTING	
SURFACE MOUNTING	
OTHER	

SASH CAT. NO

VERTICAL MOVING STD	STD
HORIZONTAL MOVING	
COMBINATION HORIZ / VERT	
SASH STOP	CAT. NO
SPECIFY HEIGHT	

SERVICE FIXTURES CAT. NO

SERVICE REQUIRED	
SERVICE REQUIRED	
SERVICE REQUIRED	
OTHER	
SPECIFY AIR,GAS,VAC,C/W OR OTHER	

ACCESS PANEL

INSIDE LOCATION	
OUTSIDE LOCATION	

ELECT. SERVICE LT CAT. NO

DUPLEX RECEPT.125V,15A	
DUPLEX RECEPT.125V, 20A	
SIMPLEX RECEPT. 250V	
DUPLEX GFI 125V, 15A	
DUPLEX GFI 125V, 20A	

CABINETS CAT. NO

SINK CABINET	
BASE CABINET	
ACID CABINET	
FLAMMABLE CABINET	
ADA	

Click to Clear Form

Clear

caution: this clears all form fields

HEMCO Corporation ISO 9001: 2008

Plan-A-UniFlow LE AireStream Fume Hoods

Click to Submit Form

Submit

window opens, select your e-mail service, add a message, press send

HEMCO Corporation PH:816-796-2900 Fax:816-796-3333 info@HEMCOCORP.COM

PLAN-A-HOOD LE AIRESTREAM FUME HOOD

SHEET 2 OF 2

CUSTOMER _____
 BY _____ DATE _____
 PHONE _____
 FAX _____
 EMAIL _____

CUSTOMER APPROVAL APPROVED AS SHOWN
 APPROVED AS NOTED (PLEASE MARK CORRECTIONS IN RED)
 NOT APPROVED (PLEASE INDICATE REASON)
 CUSTOMER SIGNATURE _____ DATE _____

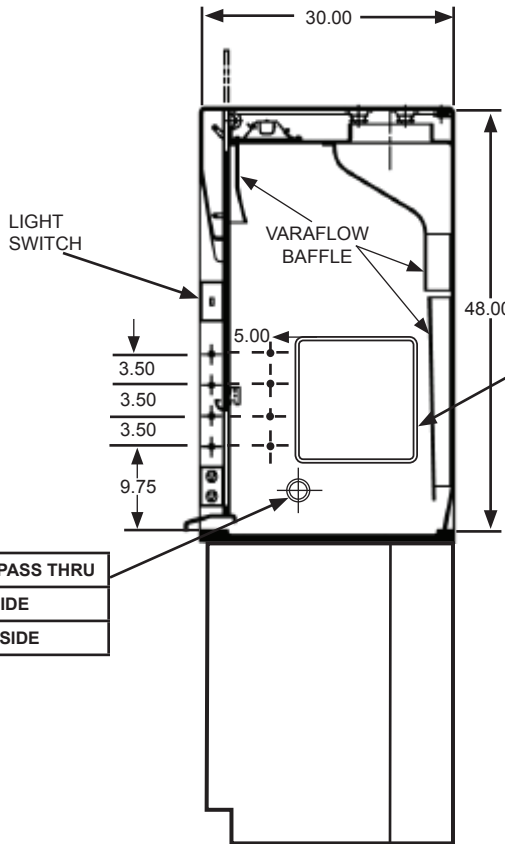

SECTION A-A
(LEFT SIDE)

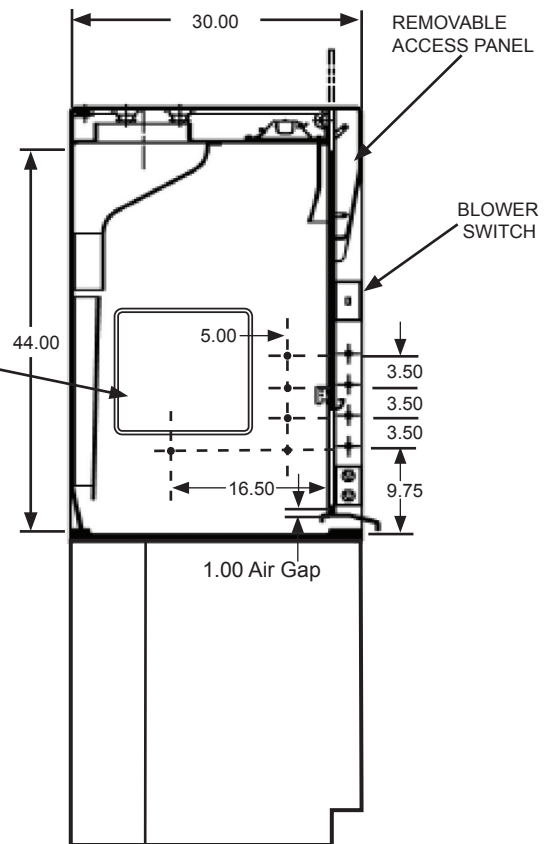

SECTION B-B
(RIGHT SIDE)

<input checked="" type="checkbox"/>	CORD PASS THRU
<input type="checkbox"/>	LEFT SIDE
<input type="checkbox"/>	RIGHT SIDE

<input checked="" type="checkbox"/>	CUP SINKS	CAT. NO
<input type="checkbox"/>	3" X 6" POLYPRO CUPSINK	
<input type="checkbox"/>	3" X 9" POLYPRO CUPSINK	
<input type="checkbox"/>	9" DIA ROUND CUPSINK	
<input type="checkbox"/>	SPECIFY LOCATION 1 2 3 4	

<input checked="" type="checkbox"/>	SINK SIZE / LOC	CAT. NO
<input type="checkbox"/>	"A"	
<input type="checkbox"/>	"B"	
<input type="checkbox"/>	"C"	
<input type="checkbox"/>	"D"	
<input type="checkbox"/>	DEPTH	

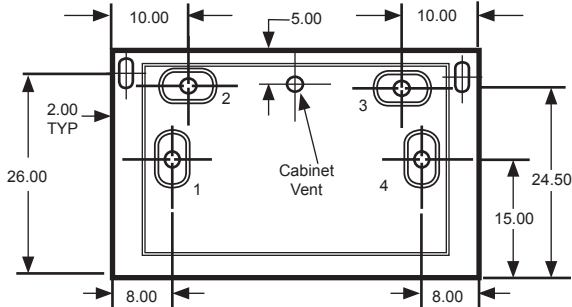

PLAN VIEW OF WORK SURFACE
CUPSINK LOCATION

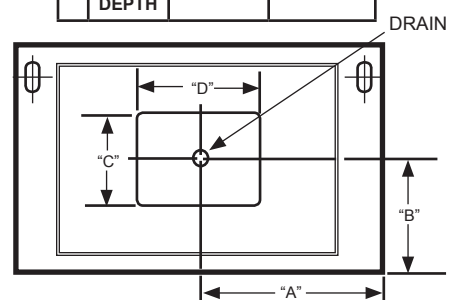

PLAN VIEW OF WORK SURFACE
SINK SIZE & LOCATION